

Delivering leading edge, innovative power solutions for more than 30 years....

Model:GTM86101-WWVV-W2

October 4, 2022

Medical 10W Wall plug in Adapter for North America and Japan, 60601-1 Certified, Nema 1-15 Input plug, 2 Prong

Information

Model Number	GTM86101-WWVV-W2
Description	GTM86101-WWVV-W2, ICT / ITE / Medical Power Supply, Wall Plug-in, AC Adaptor Power Supply AC Adaptor, , Input Rating: 100-240V~, 50-60Hz, NEMA 1-15P, North America Blades, Class II 2 Conductors, Output Rating: 12 Watts, Power rating with convection cooling (W) , 5.95-24V in 0.1V increments, Approvals: cETLus 60601-1; IP22; CB 60601-1-11; China RoHS; Double Insulation; EAC; Level VI; WEEE; VCCI; Ukraine; RoHS; PSE; PSE; CB 60601-1;

Model Picture



Agency Documents	http://www.globtek.info/certs/GTM86101/
CE EC-Declaration	https://www.globtek.com/pdf/ec_declaration/a003a00000LvGZDEA3
RoHS/RoHS2 Declaration	https://www.globtek.com/pdf/rohs_cert/a003a00000LvGZDEA3
REACH Declaration	https://www.globtek.com/pdf/iso_certificates/REACH.pdf
Conflict Minerals Declaration	https://www.globtek.com/pdf/conflict-minerals.pdf

Delivering leading edge, innovative power solutions for more than **30** years....

Model:GTM86101-WWVV-W2

October 4, 2022

MODEL PARAMETERS

Type	Wall Plug-in
Technology	AC Adaptor Power Supply AC Adaptor
Category	ICT / ITE / Medical Power Supply
Input Voltage	100-240V~, 50-60Hz
I/P Amps (A)	0.3A
Wattage (W)	12.0
Vout Range (V)	5.95-24
Efficiency Level	USA DOE Level VI / Eco-design Directive 2009/125/EC, (EU) 2019/1782
Ingress Protection	IP22
Size (mm)	69*28.8*40.3

Delivering leading edge, innovative power solutions for more than 30 years....

Model:GTM86101-WVVV-W2

October 4, 2022

ENCLOSURE

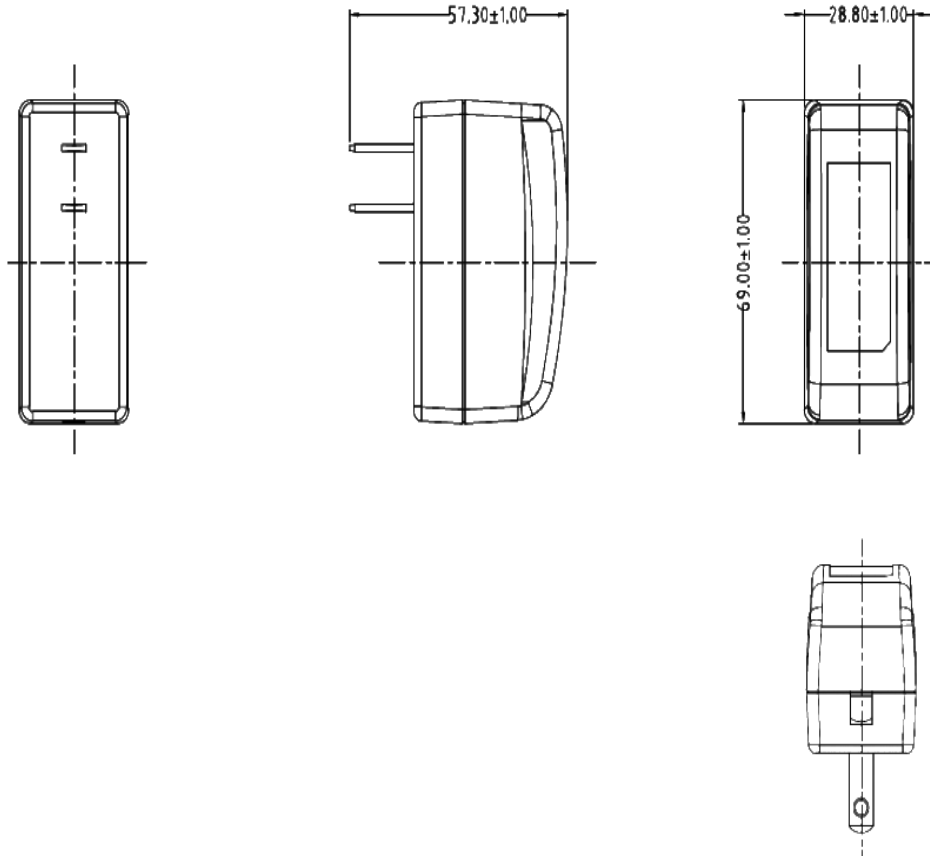

Delivering leading edge, innovative power solutions for more than **30** years....

Model:GTM86101-WWVV-W2

October 4, 2022

RATING TABLE

Model Number	Voltage	Amps(A)	Watts(W)	RFQ
GTM86101-1205.95-W2	5.95 V	2	11.90	RFQ
GTM86101-1007.5-W2	7.5 V	1.33	9.98	RFQ
GTM86101-1009-W2	9 V	1.11	9.99	RFQ
GTM86101-1212-W2	12 V	1	12.00	RFQ
GTM86101-1215-W2	15 V	0.8	12.00	RFQ
GTM86101-1224-W2	24 V	0.5	12.00	RFQ

SPECIFICATIONS

01. Input Voltage: Specified 90-264 Vac, Nameplate rated: 100-240Vac
02. Input Frequency: Specified 47-63 Hz, Nameplate rated 50/60Hz
03. Output Regulation: +/- 5%
04. Line Voltage Regulation: +/- 1%
05. Output Ripple (Vp-p): 1% or 100 mV whichever is greater, measured at 20 MHz bandwidth with 0.1 uf ceramic capacitor in parallel with a low impedance 47 uf electrolytic capacitor connected at the end of the output connector
06. Hold-up Time: 5 mS minimum
07. Inrush Current: 30A maximum @ 230Vac input
08. Energy Efficiency: Complies to Efficiency Level VI and ErP European Commission's Ecodesign Directive (2005/32/EC) / CoC Tier 2 Compliant

B) PROTECTION

01. Over-current protection: 110%-140% maximum with auto-recovery function
02. Output Over-Voltage: 110% to 130% of nominal output voltage
03. Short-circuit protection: The adapter shall not be damaged by short the DC output to Ground.

C) SAFETY

01. Dielectric Withstand Voltage: Primary To Secondary: 4000VAC or 5656VDC for 3 seconds
02. Leakage Current: 50uA maximum, at nominal 240Vac input voltage
03. ESD Immunity per EN61000-4-2, ±8 kV contact, ±15 kV air, Perf Criteria A Standard.

D) EMC

01. Emissions, per EN 55032, EN 61000-6-3, EN 61000-6-4
 - Conducted Emissions: Class B, FCC Part 15, Class B
 - Radiated Emissions: Class B, FCC Part 15, Class B
02. Line Frequency Harmonics EN61000-3-2, Class A
03. Voltage Fluctuations/Flicker EN61000-3-3
04. Immunity, per EN 55024, EN 61000-6-1, EN 61000-6-2
 - Static Discharge Immunity EN61000-4-2, 8kV Contact Discharge, 15kV air discharge
 - Radiated RF Immunity EN61000-4-3, 3V/m 80-2700MHz, 80% 1KHz AM.
 - EFT/Burst Immunity EN61000-4-4, 2kV/100kHz.
 - Line Surge Immunity EN61000-4-5, 1kV differential, 2kV common-mode
 - Conducted RF Immunity EN61000-4-6, 3Vrms, 80% 1KHz AM
 - Power Frequency Magnetic Field Immunity EN61000-4-8, NA
 - Voltage Dip Immunity EN61000-4-11, Criteria

E) OTHER:

01. MTBF: 300,000 Hours @ 25°C ambient temperature
02. Operating Temperature: 0°C to 50°C ambient temperature
03. Operating Humidity: 20 ~ 85 % RH. non-condensing
05. Storage Temperature: -20°C to 60°C
06. Storage Humidity: 5 ~ 95 % RH. non-condensing
07. Cooling: Natural convection cooling
08. RoHS 2: Complies with EU 2011/65/EU China SJ/T 11364-2014

Delivering leading edge, innovative power solutions for more than **30** years....

Model:GTM86101-WWVV-W2

October 4, 2022

F) ENCLOSURE

01. Housing: High impact plastic, 94V0 polycarbonate, non-vented
02. Markings: Label and/or Pad Printed and/or Molded in the case

F) OPTIONS:

01. Green Power On Indicator LED
 02. NEMA 1-15P or European Schuko 7-16 AC Plug Configuration
 03. Increased DC Output Voltage (up to 5.4V) to allow for long output cables
 04. Special International Safety Approvals
 05. Housing Color, special markings
-

Delivering leading edge, innovative power solutions for more than 30 years....

Model:GTM86101-WVVV-W2

October 4, 2022

DERATING CURVE

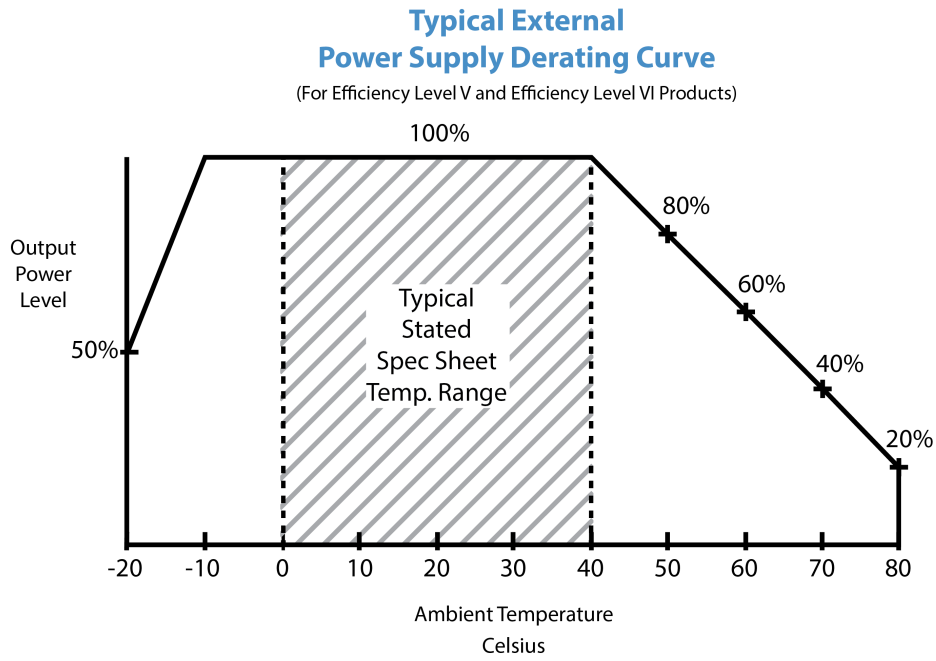

Delivering leading edge, innovative power solutions for more than **30** years....

Model:GTM86101-WVVV-W2

October 4, 2022

INPUT CONFIGURATION

Description	NEMA 1-15P, North America Blades, Class II 2 Conductors
-------------	---

All NEMA 1 devices are two-wire non-grounding devices (hot-neutral) rated for 125 V maximum. NEMA 1-15P plugs have two parallel flat blades, 0.25 inches (6.35 mm) wide, 0.06 inches (1.524 mm) thick, 0.625-0.718 inches (15.875–18.256 mm) long, and spaced 0.5 inches (12.7 mm) apart.

Delivering leading edge, innovative power solutions for more than 30 years....

Model:GTM86101-WVVV-W2

October 4, 2022

OUTPUT CONFIGURATION

Common output connector options:

 L Type (Coaxial
5.5x2.5mm plug)

 C Type (Coaxial
5.5x2.1mm plug)

 K Type (Coaxial
3.5x1.3mm plug)

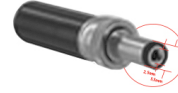
 LL Type (5.5x2.5mm
Locking 760k type)

 CL Type (5.5x2.1mm
Locking S761k type)

 ML2 Type (Molex
housing 43025-0200)

 YL3 Type
(KPPX-3P)

YL4 Type (KPPX-4P)

 EJ1/2/3/4/5 (EIAJ
RC-5320A type
connectors)

 MSB Type (Micro
USB)

 USBC Type (USB
Type C)

 Inquire for custom
design

 For a comprehensive list of options, [click here](#)







Contact GlobTek for your specific requirements or custom solutions.

Delivering leading edge, innovative power solutions for more than 30 years....

Model:GTM86101-WVVV-W2

October 4, 2022



Approvals

Logo	Description
No Logo Applicable	IEC 60601-1-11:2015
No Logo Applicable	IEC 60601-1:2005 (Third Edition) + CORR. 1 (2006) + CORR. 2 (2007) + AM1 (2012) or IEC 60601-1 (2012 reprint) (Ed 3.1) for GTM86101 only
	CHINA SJ/T 11364-2014, China RoHS Chart: http://en.globtek.com/globtek-rohs.php
	
	Declaration ДС № EAЭC N RU Д-US.KA01.B.10453_19 Custom Union of Russia, Belarus and Kazakhstan http://www.globtek.com/redirect/?loc=gost-certificate-eac-declaration
	Medical Electrical Equipment - Part 1: General Requirements For Basic Safety And Essential Performance [AAMI ES60601-1:2005 +A1]
	Indoor Use Only - Mark is on the label or Molded in the case
IP22	Ingress Protection: IP22 to IEC 60529:1989+A1:1999+A2:2013 Protected against solids objects over 12mm and Protected against vertically (and up to 15°) falling drops of water
 GlobTek, Inc.	JAPAN TUV R-PSE, Cert. No. JD 50471624, to J62368-1(H30) , J55032(H29),J3000(H25,[15V or less]. Please reference the following website for guidelines on PSE regulations: http://en.globtek.com/importing-ite-and-medical-power-supplies-ac-adaptors-to-japan/
 GlobTek, Inc.	JAPAN TUV R-PSE, Cert. No. JD 50471624 J62368-1(H30) , J55032(H29),J3000(H25),[DC15V?30V]. Please reference the following website for guidelines on PSE regulations: http://en.globtek.com/importing-ite-and-medical-power-supplies-ac-adaptors-to-japan/

Delivering leading edge, innovative power solutions for more than **30** years....

Model:GTM86101-WWVV-W2

October 4, 2022

EFFICIENCY LEVEL VI	Efficiency: complies to section 301 of Energy Independence and Security Act (EISA) complies with Energy Star tier 2 (North America), ECP tier 2 (China), MEPS tier 2 (Australia), Code of Conduct (Europe)
RoHS	Specifications of directive 2011/65/EU Annex VI (ROHS-2) with amendment 2015/863-EU (ROHS-3) http://www.ce-mark.com/Rohs%20final.pdf
 10276	Ukraine UKRSepra (Document: www.globtek.com/html/iso_certificates/GT_Ukraine.pdf)
	Japan: Voluntary Control Council for Interference (VCCI)
	WEEE: Complies with EU 2012/19/EU (http://ec.europa.eu/environment/waste/weee/index_en.htm) Mark is on the label or Molded in the case